

# NON-IMPACT BAHAMA/COLONIAL SYSTEM

For Hinges & Components see Hurricane p55 (next page)

### BAHAMA/COLONIAL HOLLOW BLADE x 16'

80-MF-011 M/F (#8 screw)  
 80-WH-011 White (#8 screw)  
 Mates with Punched Frame and Cap

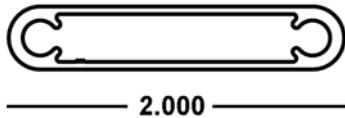

NON  
ASSA  
PRODUCT

### BAHAMA/COLONIAL SOLID BLADE x 20'

52-63-4696 M/F 20 pcs  
 52-63-3060 White 24 pcs  
 Mates with Punched Frame and Cap

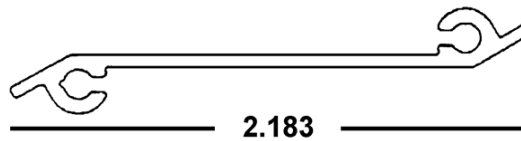

NON  
ASSA  
PRODUCT

### MALE BAHAMA FRAME (with Hinge) x 20'

52-63-8535 M/F

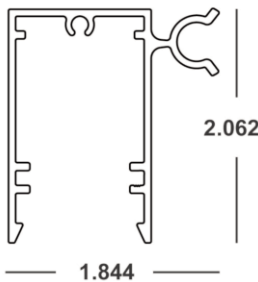

NON  
ASSA  
PRODUCT

### BAHAMA/COLONIAL FRAME x 20'

52-63-4694 M/F 8 pcs  
 80-WH-012 White 6 pcs

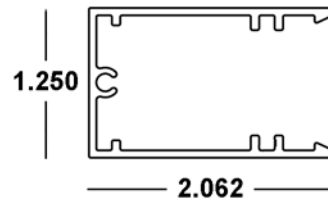

NON  
ASSA  
PRODUCT

Copyright 2007-2014 Eastern Metal Supply, Inc. HVTM, BERTHA HV®, BERTHA®, DACROSHIELD® are all trademarks of Eastern Metal Supply, Inc. ASSA® is a trademark of the American Shutter Systems Association. All rights reserved.

### BAHAMA/COLONIAL CENTER MULLION

MILL ORDER 52-63-4695  
 MILL ORDER 52-63-4695P (punched)

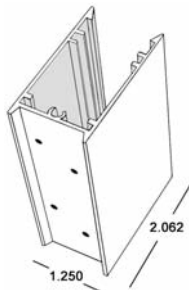

NON  
ASSA  
PRODUCT

### 2" X .093" ARCHITECTURAL ANGLE x 24' 3" (Corner Key)

52-63-5805A M/F

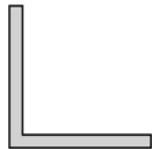

For Storm Protection Shutter to be backed with .050 sheet

NON  
ASSA  
PRODUCT

### BAHAMA/COLONIAL FRAME CAP x 20' (Punched & Unpunched)

**punched\* (left) 20 pcs** (mates with Frame)  
 52-63-4698L M/F  
**punched\* (right) 20 pcs** (mates with Mullion & Frame)  
 52-63-4698R M/F  
**unpunched 16 pcs** (mates with Frame)  
 52-63-4698 M/F

NON  
ASSA  
PRODUCT

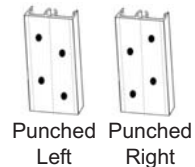
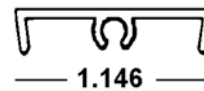

## RATED NON-IMPACT DECORATIVE SHADE AWNING

For Hinges & Components see Hurricane p55 (next page)

### H-Mullion x 26' 9"

52-63-1706 6063-T6 Mill Finish

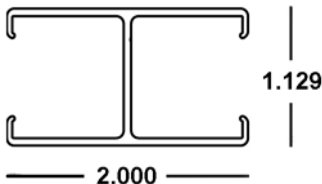

### Horizontal Tube x 26' 9"

52-63-058 6063-T6 Mill Finish

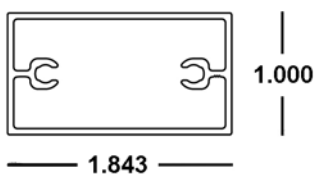

### Shutter Jamb x 26' 9"

52-63-059 6063-T6 Mill Finish

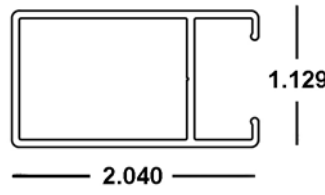

### Louver Blade x 12' 2"

52-63-060 6063-T6 Mill Finish

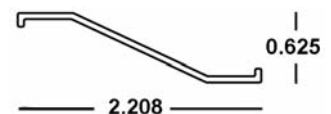

\* Blade slides into punched .050 sheet and inserts into Shutter Jamb slot.

Hurricane 54



**Eastern Metal Supply**  
 Quality Shapes In Aluminum

#### EMS FL

1-800-432-2204  
 (561) 588-4780 - fax

#### EMS NC

1-800-343-8154  
 (704) 391-2267 - fax

#### EMS TX

1-800-996-6061  
 (281) 656-2297 - fax

#### EMS MO

1-888-822-6061  
 (314) 344-3349 - fax



**Additional Locations:** West Palm Beach & Lakeland, FL; Newark, DE; Birmingham, AL; Akron, OH; Van Buren, AR  
**website:** [www.EasternMetal.com](http://www.EasternMetal.com) **e-mail:** [info@EasternMetal.com](mailto:info@EasternMetal.com) **version:** 03/28/18

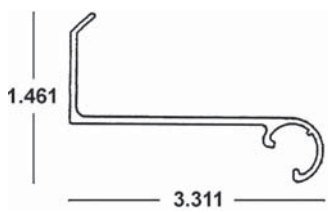
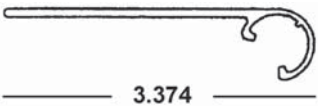
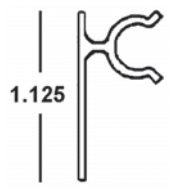

# BAHAMA/COLONIAL HINGES & COMPONENTS

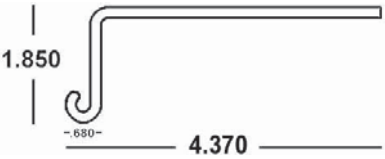
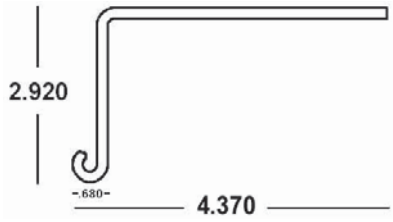
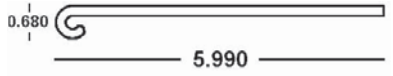
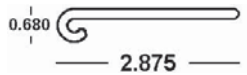
Used in a variety of Bahama/Colonial Systems

<p><b>Bahama Female Hinge x 20'</b> 41-63-803 Mill Finish      6 pcs</p> 	<p><b>1" Build-Out Bahama Female Hinge x 20'</b> 41-63-804 Mill Finish      6 pcs</p> 	<p><b>Bahama Female Flat Hinge x 20'</b> 41-63-805 Mill Finish      6 pcs</p> 	<p><b>Bahama Male Hinge x 20'</b> 41-63-814 Mill Finish      16 pcs</p> 
--	---	--	---

<p><b>Colonial Single Hinge x 12'</b> Mill Finish 6 pcs 41-63-816      <i>Wall Mount</i> <i>Mates with 41-63-824N</i></p> 	<p><b>Colonial Double Hinge x 12'</b> Mill Finish 4 pcs 41-63-813      <i>Wall Mount</i> <i>Mates with 41-63-824N</i></p> 	<p><b>Colonial Flat Hinge x 12'</b> 41-63-811      <i>Wall Mount</i> Mill Finish 6 pcs; <i>Mates with 41-63-824N</i></p>  <p><b>Colonial Flat Hinge x 12'</b> 41-63-824N      <i>Shutter Mount</i> Mill Finish 6 pcs; <i>Mates with 41-63-816, 41-63-813, 41-63-811, 41-63-824N</i></p> 
---	--	--

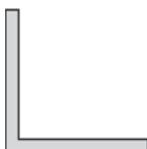
<p><b>HV™ Bahama Telescoping Arm Kit</b> <i>Kit includes Slip Collar, Camel Back, Cap and U-Clip. Lengths shown are maximum length of telescoping tubes.</i></p> <table style="width: 100%; border: none;"> <tr><td><u>7002K</u></td><td>12" MF</td></tr> <tr><td><u>7002KWH</u></td><td>12" White</td></tr> <tr><td><u>7002KBK</u></td><td>12" Black</td></tr> <tr><td><u>7002KMB</u></td><td>12" Bronze</td></tr> <tr><td><u>7003K (FL/TX)</u></td><td>18" MF</td></tr> <tr><td><u>7003KWH</u></td><td>18" White</td></tr> <tr><td><u>7003KBK</u></td><td>18" Black</td></tr> <tr><td><u>7003KMB</u></td><td>18" Bronze</td></tr> <tr><td><u>7004K (FL/TX)</u></td><td>24" MF</td></tr> <tr><td><u>7004KWH</u></td><td>24" White</td></tr> <tr><td><u>7004KBK (FL/TX)</u></td><td>24" Black</td></tr> <tr><td><u>7004KMB</u></td><td>24" Bronze</td></tr> </table> 	<u>7002K</u>	12" MF	<u>7002KWH</u>	12" White	<u>7002KBK</u>	12" Black	<u>7002KMB</u>	12" Bronze	<u>7003K (FL/TX)</u>	18" MF	<u>7003KWH</u>	18" White	<u>7003KBK</u>	18" Black	<u>7003KMB</u>	18" Bronze	<u>7004K (FL/TX)</u>	24" MF	<u>7004KWH</u>	24" White	<u>7004KBK (FL/TX)</u>	24" Black	<u>7004KMB</u>	24" Bronze	<p><b>HV™ Bahama Telescoping Arm Kit</b> <i>Kit includes Slip Collar, Camel Back, Cap and U-Clip. Lengths shown are maximum length of telescoping tubes.</i></p> <table style="width: 100%; border: none;"> <tr><td><u>7017K</u></td><td>30" MF</td></tr> <tr><td><u>7017KWH</u></td><td>30" White</td></tr> <tr><td><u>7017KBK</u></td><td>30" Black</td></tr> <tr><td><u>7017KMB</u></td><td>30" Bronze</td></tr> <tr><td><u>7018K</u></td><td>36" MF</td></tr> <tr><td><u>7018KWH</u></td><td>36" White</td></tr> <tr><td><u>7018KBK</u></td><td>36" Black</td></tr> <tr><td><u>7018KMB</u></td><td>36" Bronze</td></tr> </table> 	<u>7017K</u>	30" MF	<u>7017KWH</u>	30" White	<u>7017KBK</u>	30" Black	<u>7017KMB</u>	30" Bronze	<u>7018K</u>	36" MF	<u>7018KWH</u>	36" White	<u>7018KBK</u>	36" Black	<u>7018KMB</u>	36" Bronze	<p><b>1" SLIP COLLAR WITH THUMB SCREW</b> <i>Accepts 1" Serrated Tube for Telescoping Arms</i></p> <table style="width: 100%; border: none;"> <tr><td><u>7000 (FL/TX)</u></td><td>Mill Finish x 9/16"</td></tr> <tr><td><u>7000WH</u></td><td>White x 9/16"</td></tr> <tr><td><u>7000BK</u></td><td>Black x 9/16"</td></tr> <tr><td><u>7000MB</u></td><td>Bronze x 9/16"</td></tr> <tr><td><u>MILL ORDER</u></td><td>52-63-2484 MF x 20"</td></tr> <tr><td><u>52-00-139 (TX)</u></td><td>Mill Finish x 9/16" (No Thumbscrew)</td></tr> <tr><td><u>41014 (TX)</u></td><td>1/4-20 x 3/4 Thumbscrew (mates with 52-00-139)</td></tr> <tr><td><u>41021 (TX)</u></td><td>1/4-20 x 1 Thumbscrew (mates with 52-00-139)</td></tr> </table> <p><b>CAMEL BACK CLIP WITH PIN</b></p> <table style="width: 100%; border: none;"> <tr><td><u>7001</u></td><td>Mill Finish</td></tr> <tr><td><u>7001WH</u></td><td>White</td></tr> <tr><td><u>7001BK</u></td><td>Black</td></tr> <tr><td><u>7001MB</u></td><td>Bronze</td></tr> <tr><td><u>41010 (TX)</u></td><td>Camel Back Clip (no pin)</td></tr> <tr><td><u>41012 (TX)</u></td><td>Camel Back Pin</td></tr> </table> 	<u>7000 (FL/TX)</u>	Mill Finish x 9/16"	<u>7000WH</u>	White x 9/16"	<u>7000BK</u>	Black x 9/16"	<u>7000MB</u>	Bronze x 9/16"	<u>MILL ORDER</u>	52-63-2484 MF x 20"	<u>52-00-139 (TX)</u>	Mill Finish x 9/16" (No Thumbscrew)	<u>41014 (TX)</u>	1/4-20 x 3/4 Thumbscrew (mates with 52-00-139)	<u>41021 (TX)</u>	1/4-20 x 1 Thumbscrew (mates with 52-00-139)	<u>7001</u>	Mill Finish	<u>7001WH</u>	White	<u>7001BK</u>	Black	<u>7001MB</u>	Bronze	<u>41010 (TX)</u>	Camel Back Clip (no pin)	<u>41012 (TX)</u>	Camel Back Pin
<u>7002K</u>	12" MF																																																																					
<u>7002KWH</u>	12" White																																																																					
<u>7002KBK</u>	12" Black																																																																					
<u>7002KMB</u>	12" Bronze																																																																					
<u>7003K (FL/TX)</u>	18" MF																																																																					
<u>7003KWH</u>	18" White																																																																					
<u>7003KBK</u>	18" Black																																																																					
<u>7003KMB</u>	18" Bronze																																																																					
<u>7004K (FL/TX)</u>	24" MF																																																																					
<u>7004KWH</u>	24" White																																																																					
<u>7004KBK (FL/TX)</u>	24" Black																																																																					
<u>7004KMB</u>	24" Bronze																																																																					
<u>7017K</u>	30" MF																																																																					
<u>7017KWH</u>	30" White																																																																					
<u>7017KBK</u>	30" Black																																																																					
<u>7017KMB</u>	30" Bronze																																																																					
<u>7018K</u>	36" MF																																																																					
<u>7018KWH</u>	36" White																																																																					
<u>7018KBK</u>	36" Black																																																																					
<u>7018KMB</u>	36" Bronze																																																																					
<u>7000 (FL/TX)</u>	Mill Finish x 9/16"																																																																					
<u>7000WH</u>	White x 9/16"																																																																					
<u>7000BK</u>	Black x 9/16"																																																																					
<u>7000MB</u>	Bronze x 9/16"																																																																					
<u>MILL ORDER</u>	52-63-2484 MF x 20"																																																																					
<u>52-00-139 (TX)</u>	Mill Finish x 9/16" (No Thumbscrew)																																																																					
<u>41014 (TX)</u>	1/4-20 x 3/4 Thumbscrew (mates with 52-00-139)																																																																					
<u>41021 (TX)</u>	1/4-20 x 1 Thumbscrew (mates with 52-00-139)																																																																					
<u>7001</u>	Mill Finish																																																																					
<u>7001WH</u>	White																																																																					
<u>7001BK</u>	Black																																																																					
<u>7001MB</u>	Bronze																																																																					
<u>41010 (TX)</u>	Camel Back Clip (no pin)																																																																					
<u>41012 (TX)</u>	Camel Back Pin																																																																					

<p><b>Telescoping Serrated Tube x 20'</b> Mill Finish</p> <table style="width: 100%; border: none;"> <tr><td>52-63-537</td><td>.875"</td><td>26 pcs</td></tr> <tr><td>51-63-381</td><td>1.000"</td><td>32 pcs</td></tr> </table> 	52-63-537	.875"	26 pcs	51-63-381	1.000"	32 pcs	<p><b>Corner Key/Tie Down</b> Mill Finish Angle</p> <table style="width: 100%; border: none;"> <tr><td>2 x 2 x 1/8 x 20'</td><td>11-63-315</td></tr> <tr><td>2 x 2 x 3/16 x 20'</td><td>11-63-320</td></tr> </table> 	2 x 2 x 1/8 x 20'	11-63-315	2 x 2 x 3/16 x 20'	11-63-320	<p><b>Fixed Low Pro Colonial Mounting Bracket</b> 1.5 x 1.5 x .062 Angle Pre-Drilled 3/16" Holes</p> <table style="width: 100%; border: none;"> <tr><td><u>7058</u></td><td>x 4"</td></tr> <tr><td><u>7053</u></td><td>x 10"</td></tr> <tr><td><u>7055</u></td><td>x 14"</td></tr> </table> 	<u>7058</u>	x 4"	<u>7053</u>	x 10"	<u>7055</u>	x 14"	<p><b>Low Pro Hold Back Clip</b> Sold in Pairs (box of 100) <u>LP-HOLDBACK</u></p>  <p style="font-size: small; text-align: right;">Copyright 2007-2016 Eastern Metal Supply, Inc. HV™ BERTHA HV®, BERTHA® are all trademarks of Eastern Metal Supply, Inc. ASSA® is a trademark of the American Shutter Systems Association. All rights reserved.</p>
52-63-537	.875"	26 pcs																	
51-63-381	1.000"	32 pcs																	
2 x 2 x 1/8 x 20'	11-63-315																		
2 x 2 x 3/16 x 20'	11-63-320																		
<u>7058</u>	x 4"																		
<u>7053</u>	x 10"																		
<u>7055</u>	x 14"																		

Hurricane 55



**Eastern Metal Supply**  
Quality Shapes In Aluminum

**EMS FL**

1-800-432-2204  
(561) 588-4780 - fax

**EMS NC**

1-800-343-8154  
(704) 391-2267 - fax

**EMS TX**

1-800-996-6061  
(281) 656-2297 - fax

**EMS MO**

1-888-822-6061  
(314) 344-3349 - fax

Additional Locations: West Palm Beach & Lakeland, FL; Newark, DE and Birmingham, AL

website: [www.EasternMetal.com](http://www.EasternMetal.com)

e-mail: [info@EasternMetal.com](mailto:info@EasternMetal.com)

version: 08/18/16